

**Myers MSR12-4
Smart relay**

User manual



PREMIUM SMART HOME SYSTEMS
by PARTIZAN

- 1. How to start..... 3**
- 2. Main elements of the device..... 5**
 - 2.1. Operation modes.....7
 - 2.1.1. Inching operation mode.....7
 - 2.1.2. Self-locking operation mode.....8
 - 2.1.3. Interlock operation mode9
- 3. Adding a relay to Partizan mobile application..... 11**
 - 3.1. Download and install Partizan mobile application 11
 - 3.2. Launch Partizan mobile application and follow instructions 11
 - 3.3. Setting up operation modes in Partizan mobile application..... 15
 - 3.3.1. Controls console, appearance..... 15
 - 3.3.2. Setup menu 16
 - 3.3.3. Relay names 16
 - 3.3.4. Relay setup..... 17
 - 3.3.5. Relay schedule 18
 - 3.3.6. Shared access 19
 - 3.3.7. Delete the device 19

1. How to start

This device supports **Partizan Cloud Storage** service and **Partizan** mobile application for iOS and Android.

Partizan Cloud Storage benefits:



Your data cannot be stolen or damaged.



No one can access your devices, live and archived video without your permission.



Access to your account and devices from anywhere in the world. Even mobile Internet is enough.



Partizan app won "**Best Mobile Video Surveillance App 2019**" international award.

To take full advantage of the device, **install Partizan mobile application** for iOS or Android:



Partizan mobile application for iOS:

<https://apps.apple.com/app/partizan/id1473001227>



Partizan mobile application for Android:

<https://play.google.com/store/apps/details?id=com.partizan.pro>

To work with this device you need to **sign in to your cloud account**.

Open the app, use an **existing account** or **create a new one**:

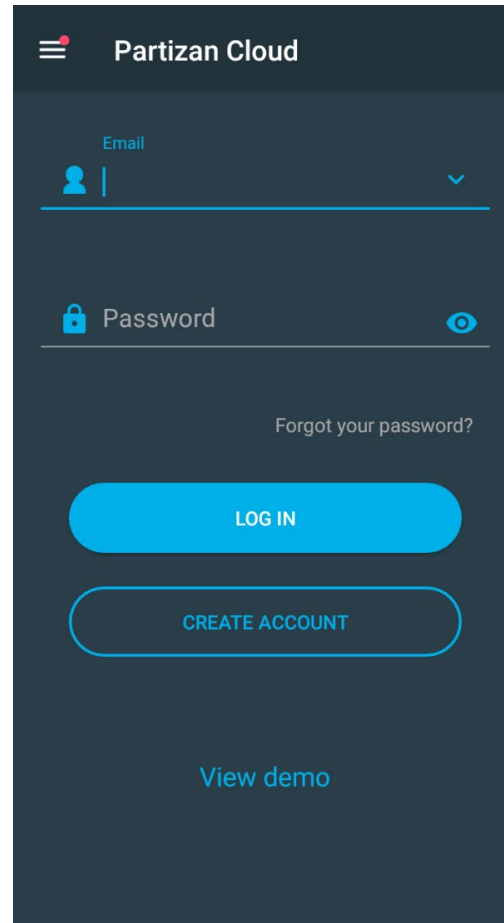
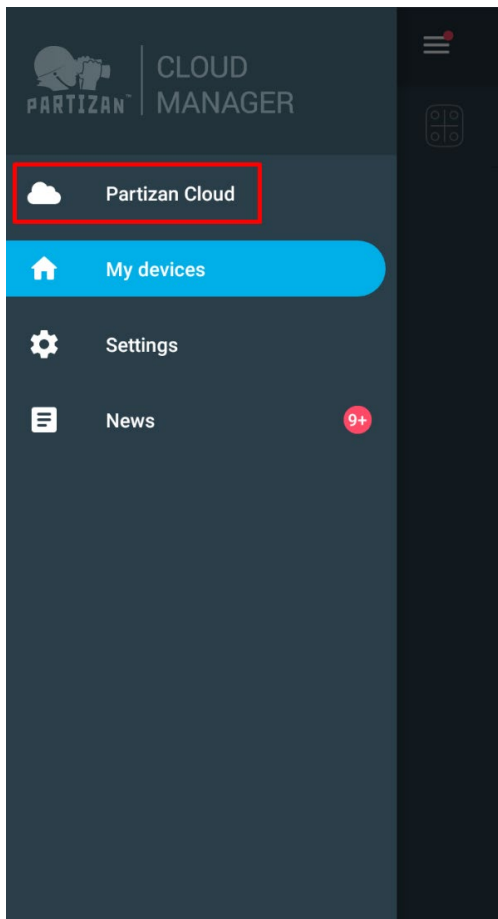
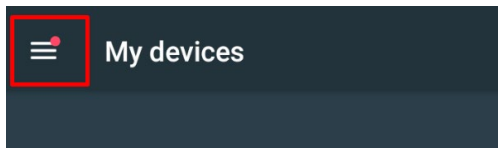

After signing into the cloud account you can go directly to device setting.

If you have any questions,
please contact our technical support:

E-mail: support@partizan.global

Skype: partizan-support

Chat: +42 077 673 78 89 (Viber, Telegram, WhatsApp)



Technical support working time:
<https://partizan.global/support/technical-support>



Partizan software:
<https://apps.partizan.global/>

2. Main elements of the device

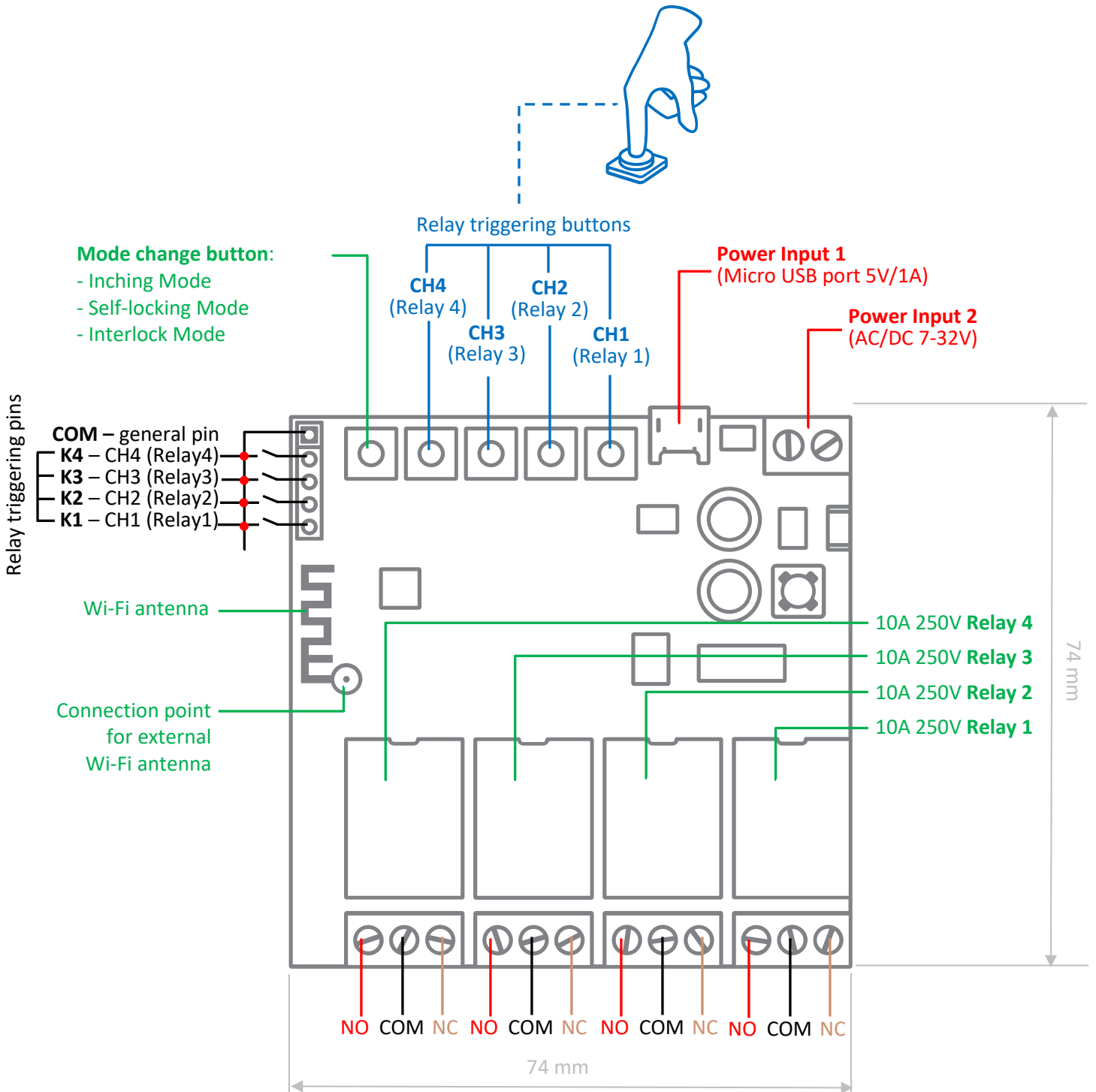

Power connectors - the relay is powered by connecting AC / DC 7-32V power supply or a power supply unit with a Micro USB connector.

Relay is a device that is equipped with 4 relays 10A / 250V each.

Each relay has NO (normally open) and NC (normally closed) ports, which are selected based on the required functionality.

Control buttons:

CH1 - manual activation of the first relay / activation of adding to mobile application using Wireless Connect.

CH2-CH4 - manual activation of relay 2-4.

MODE - selection of the relay operation mode. The following operation modes are also available: Inching mode, Self-locking mode, Interlock mode.

***Wi-Fi operation mode:**

- Standart – IEEE 802.11b/g/n
- Modulation – DSSS/OFDM
- Bandwidth – 20000kHz
- Frequency – 2.412 – 2.472 MHz
- Max. wireless power less then 100mW

2.1. Operation modes

2.1.1. Inching operation mode

In this mode, the channel relay is activated for a short period of time (0.7 seconds by default), then the relay returns to stasis.

This mode is suitable for electromechanical and electromagnetic locks opening.



ATTENTION! Danger of electric shock! The electrical connection must only be carried out by qualified personnel!

It is necessary to disconnect the power supply (turn off the main switch / fuse) before installation.

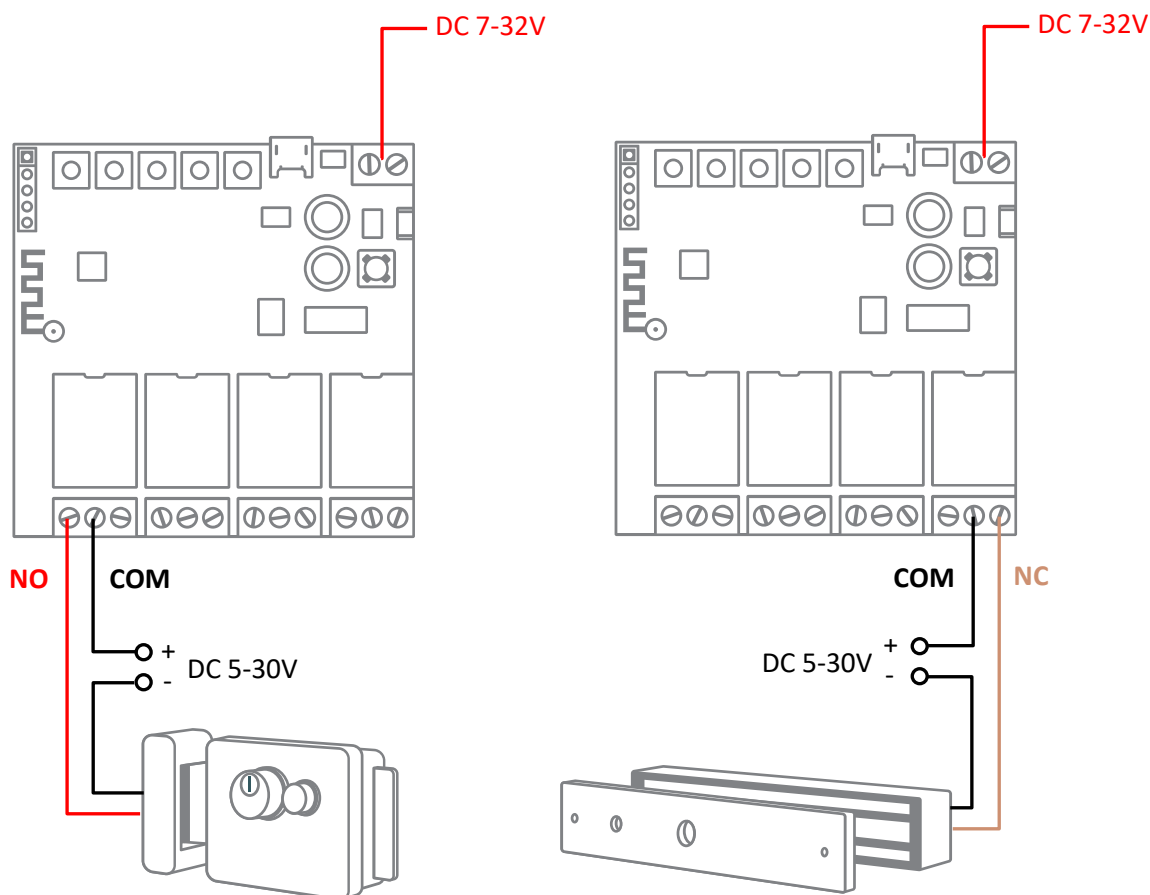

2.1.2. Self-locking operation mode

The relay is activated on command and remains active until a second command is received.

This mode is suitable for turning on / off household appliances, lighting lamps, etc.



ATTENTION! Danger of electric shock! The electrical connection must only be carried out by qualified personnel!

It is necessary to disconnect the power supply (turn off the main switch / fuse) before installation.

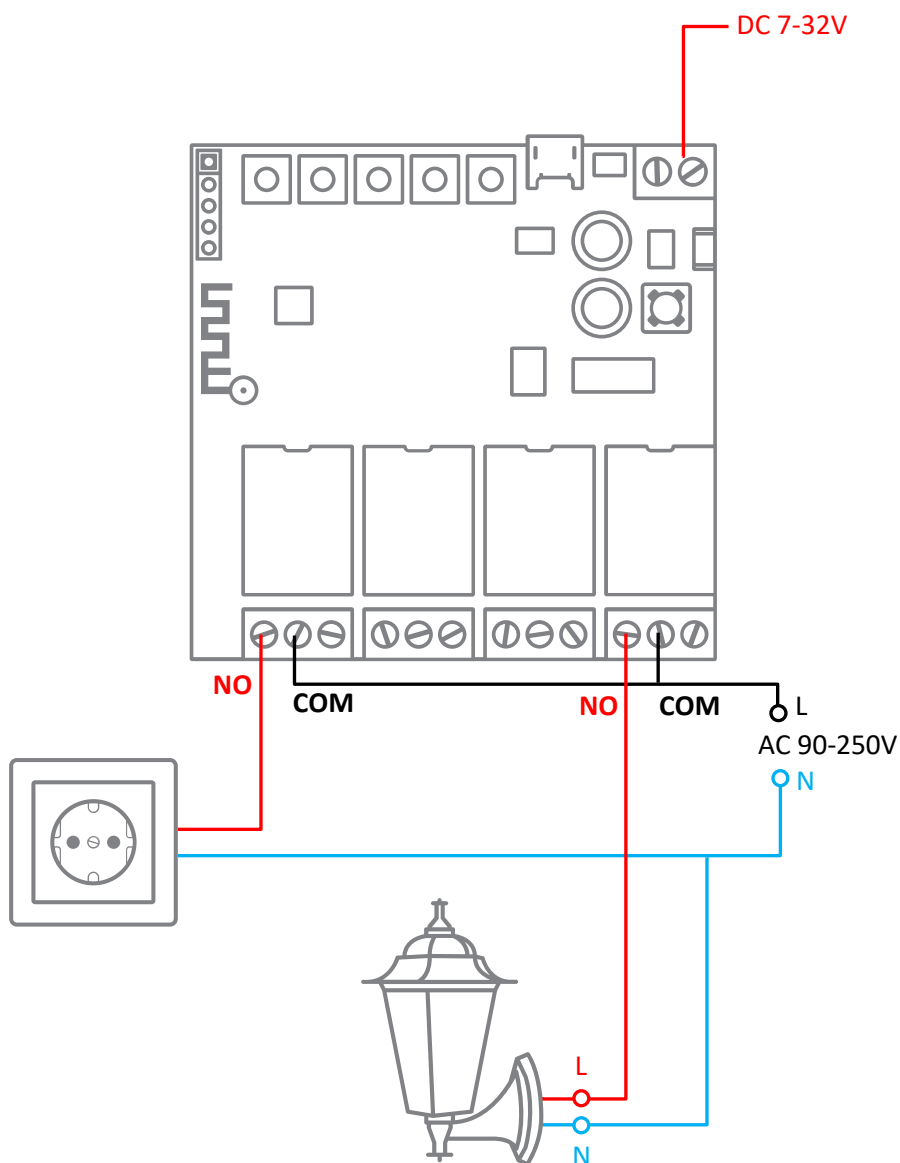

2.1.3. Interlock operation mode

In this mode, the relays work in pairs. When one relay is activated, the second relay is deactivated.

This mode is suitable for connecting electric engines with revers function, performing the "Gateway" mode, controlling the gate, etc.

** This connection diagram is just an example, for correct connection it is necessary to study the diagram of the connected device.*



ATTENTION! Danger of electric shock! The electrical connection must only be carried out by qualified personnel!

It is necessary to disconnect the power supply (turn off the main switch / fuse) before installation.

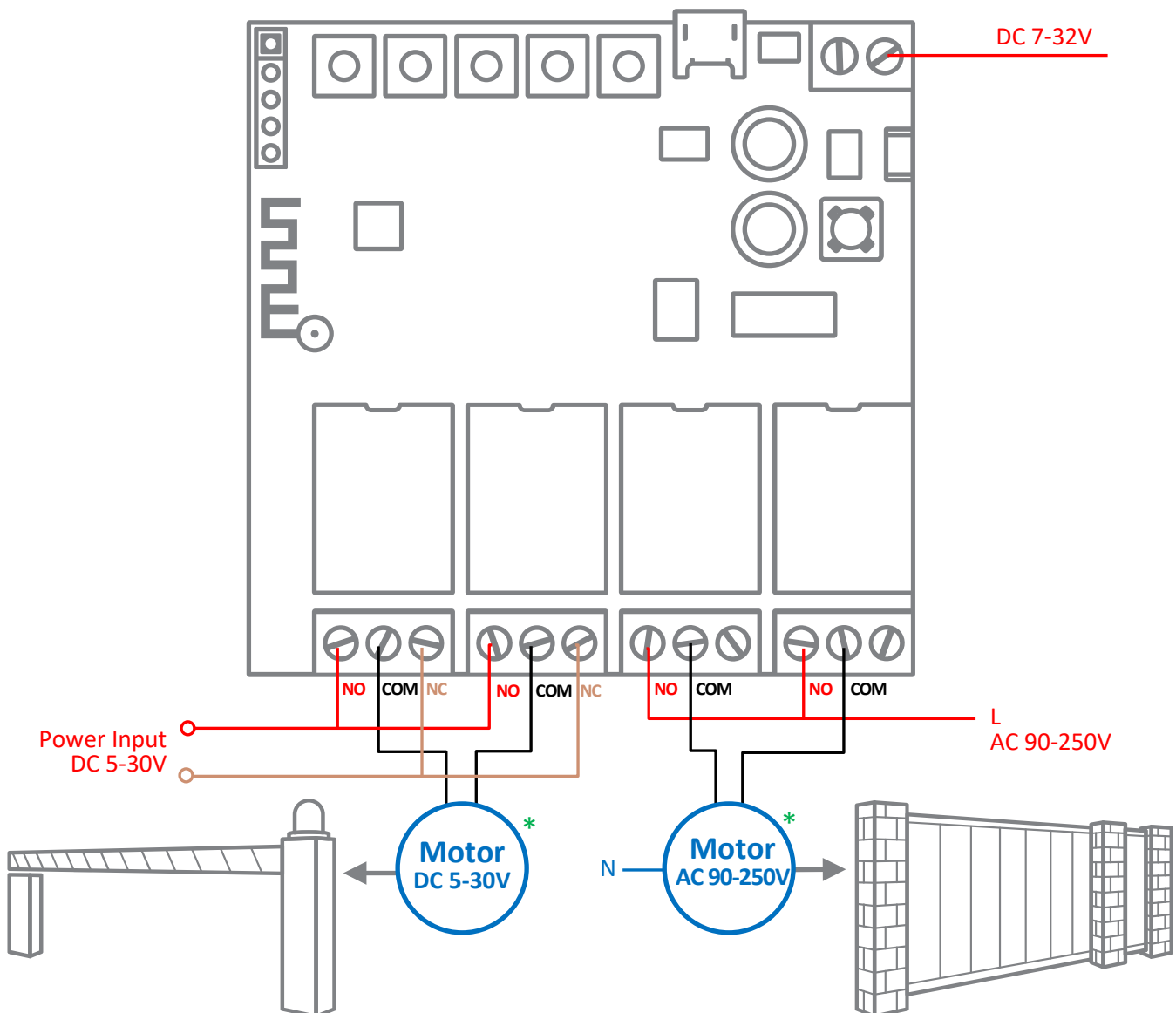

An example of performing the "Gateway" mode: when the first door is opened, the second remains closed and vice versa, when the second door is opened, the first remains closed.



ATTENTION! Danger of electric shock! The electrical connection must only be carried out by qualified personnel!

It is necessary to disconnect the power supply (turn off the main switch / fuse) before installation.

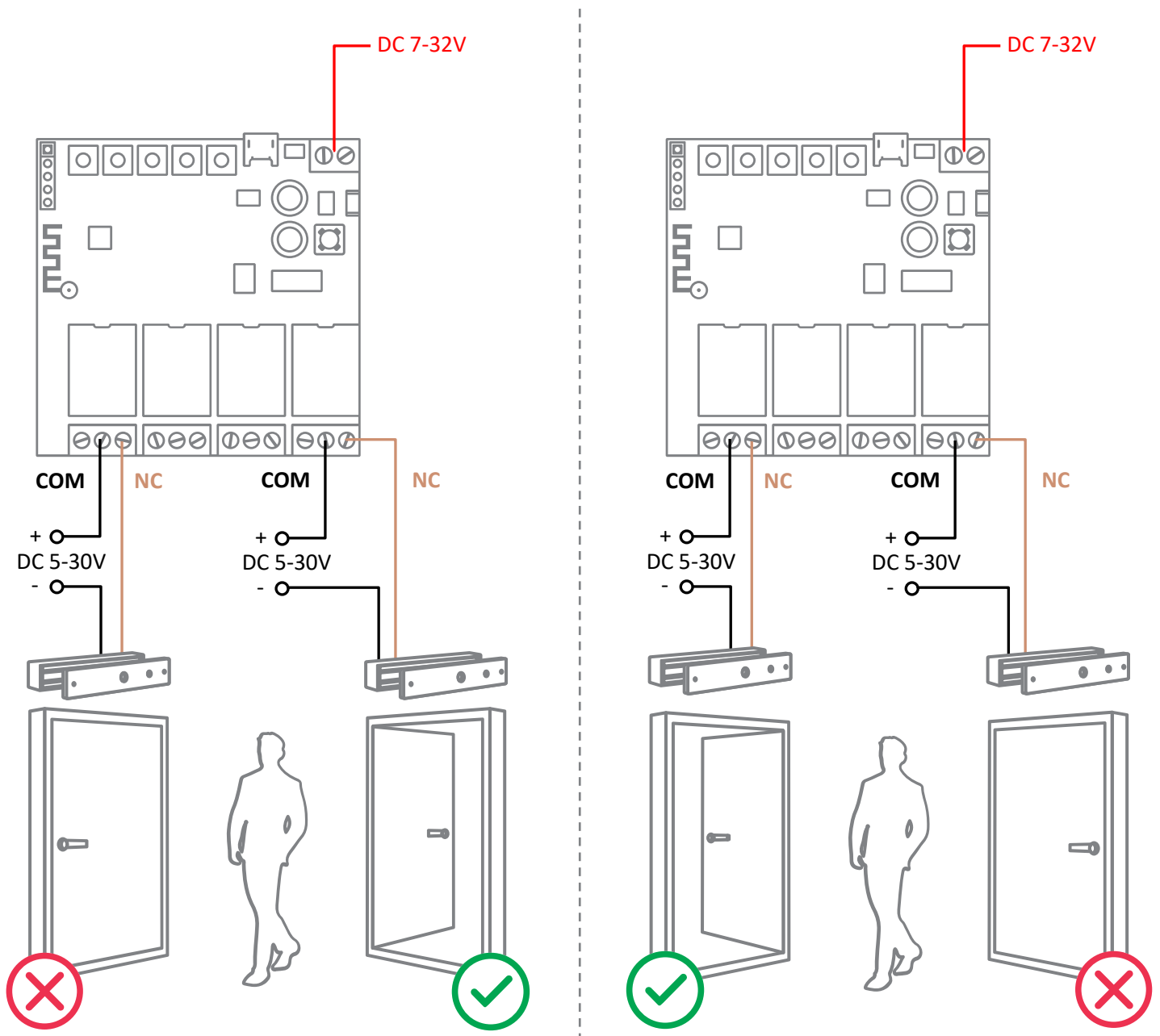

3. Adding a relay to Partizan mobile application

3.1. Download and install Partizan mobile application



Partizan mobile application for iOS:

<https://apps.apple.com/app/partizan/id1473001227>



Partizan mobile application for Android:

<https://play.google.com/store/apps/details?id=com.partizan.pro>

3.2. Launch Partizan mobile application and follow instructions

Нажмите **кнопку “+”** (в правом верхнем углу экрана для iOS или в правом нижнем углу экрана для Android).

Нажмите **“Add device”**.

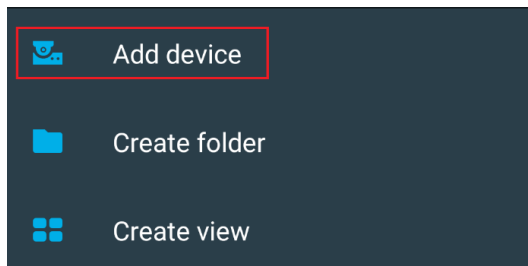

Choose device connection type **“Wireless Connect”**.

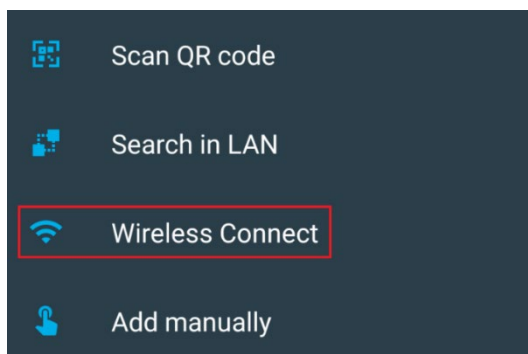

Chose "Smart Relay" device.

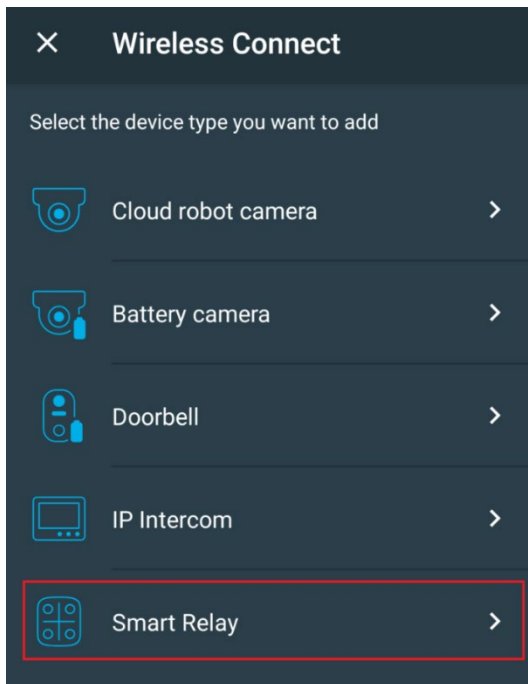

To work with this type of device you need to sign in to your cloud account. Use an **existing account** or **create a new one**.

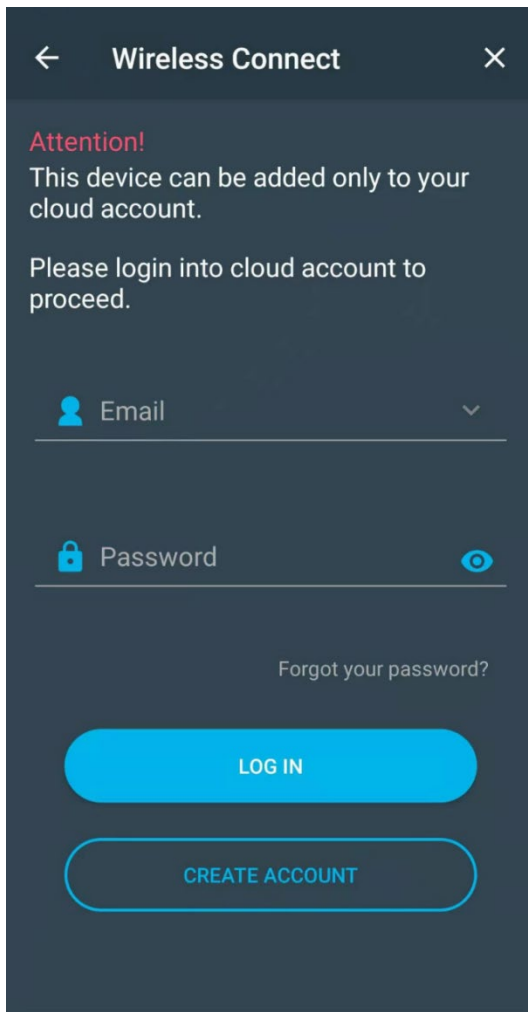

Enter your Wi-Fi network registration data of (network name and password) to which the mobile phone is connected. **The network standard must be 2.4GHz!**

Press **“Next”**.

Switch the device on.

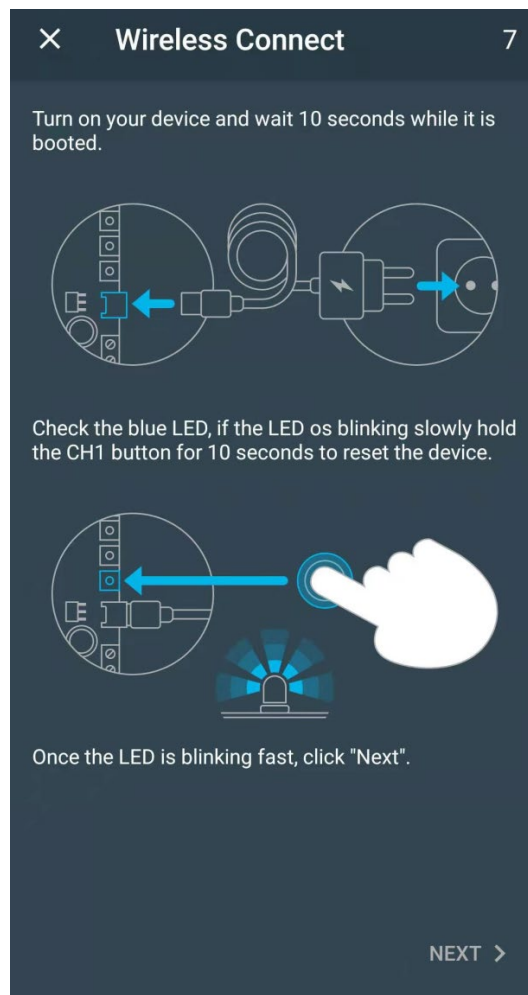
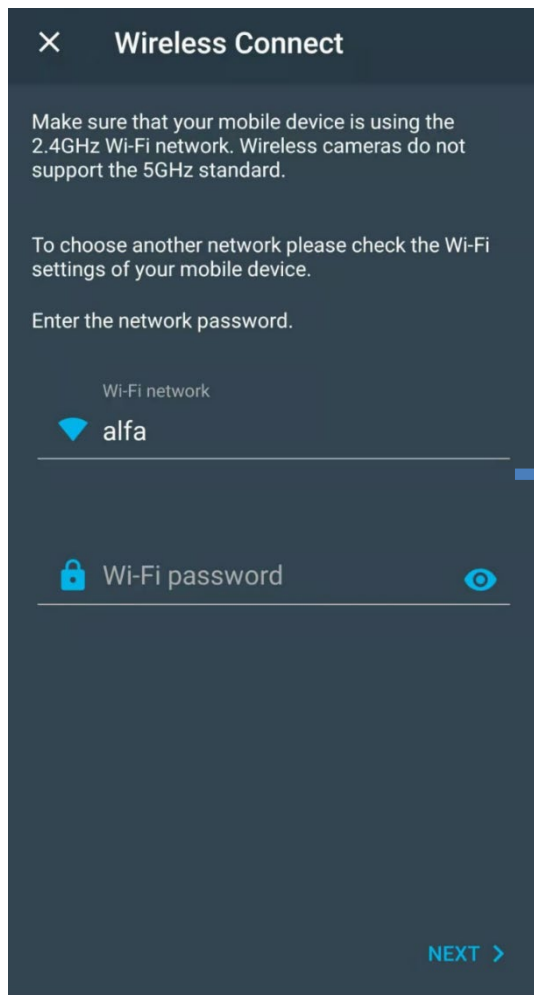

Wait 10 seconds for the device to boot.

Check the blue indicator, if it blinks slowly, then **hold down the CH1 button** for 10 seconds, after which the device will be added to mobile application using Wireless Connect technology. Blue indicator will blink quickly.

Press **“Next”**.

The relay will receive Wi-Fi network registration data, connect and add the device to your cloud account list of devices.

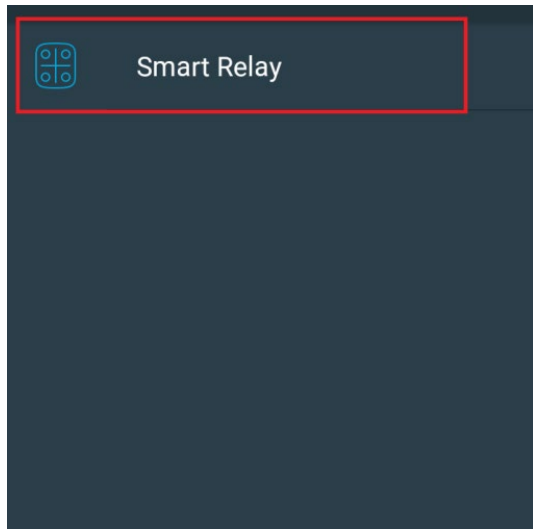

3.3. Setting up operation modes in Partizan mobile application

Chose the relay in the list of added devices.

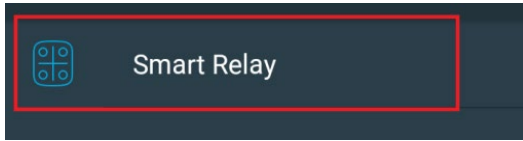

3.3.1. Controls console, appearance.

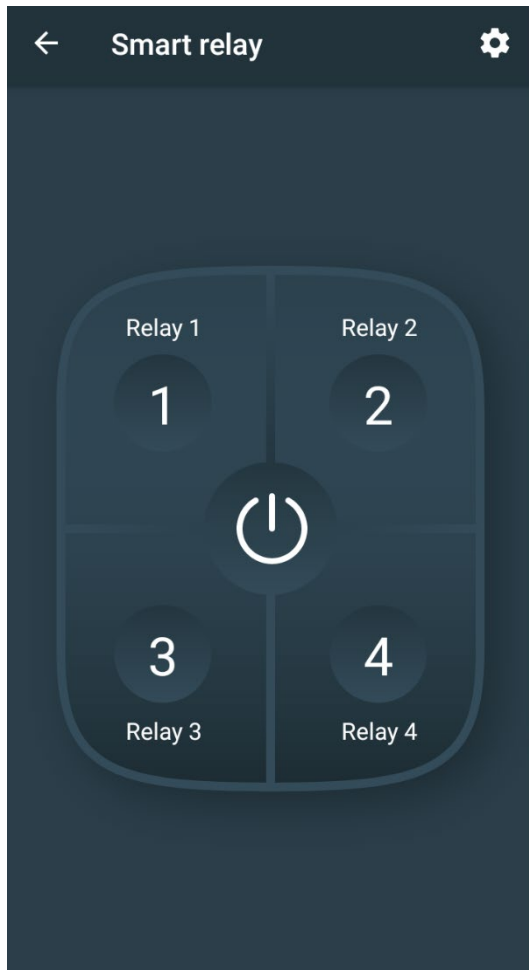

1-4 – relay on/off buttons.

 - **power on/off** of all relays.

 - enter **Setup menu**.

3.3.2. Setup menu

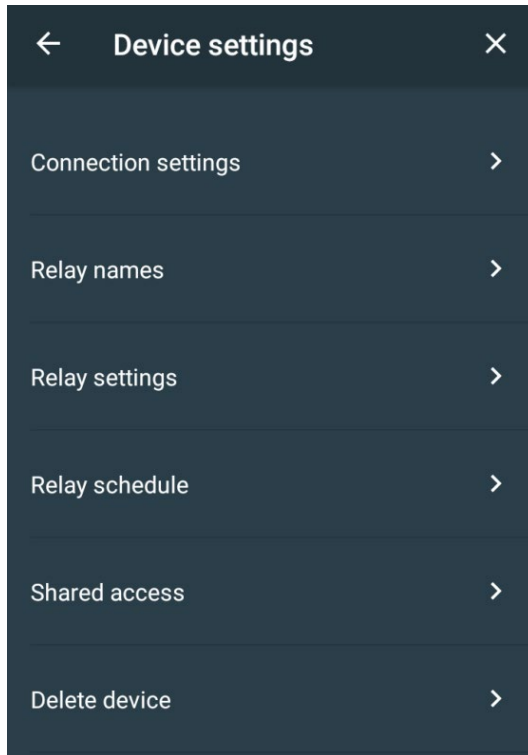

3.3.3. Relay names

In this item the names for relay buttons are set

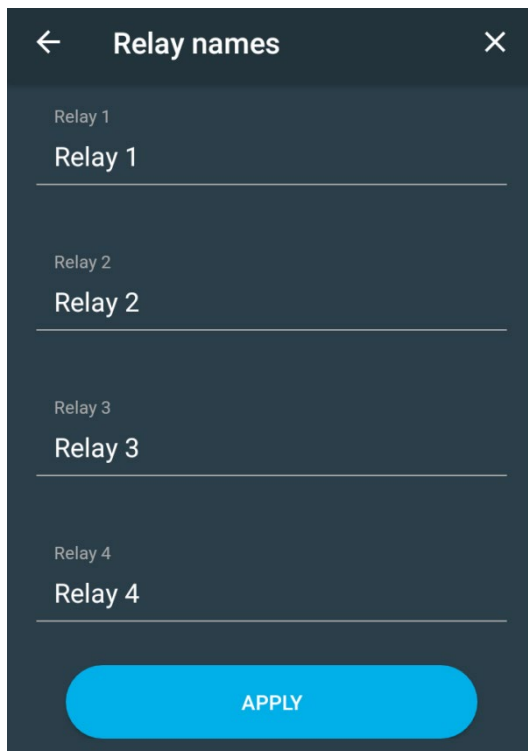

3.3.4. Relay setup

Setup of device operation modes (Inching/Self-locking/Interlock)

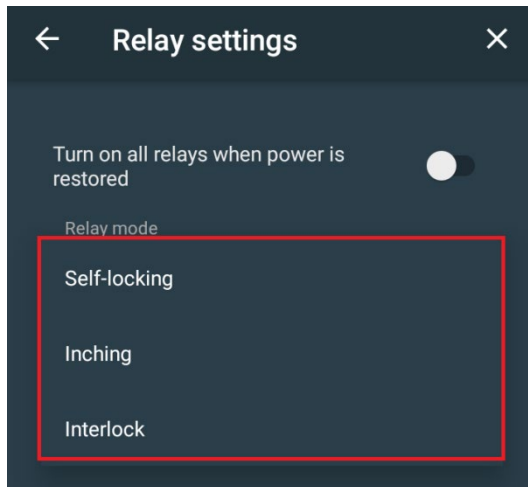

An **option to set the duration of inching interval** is available in inching mode.

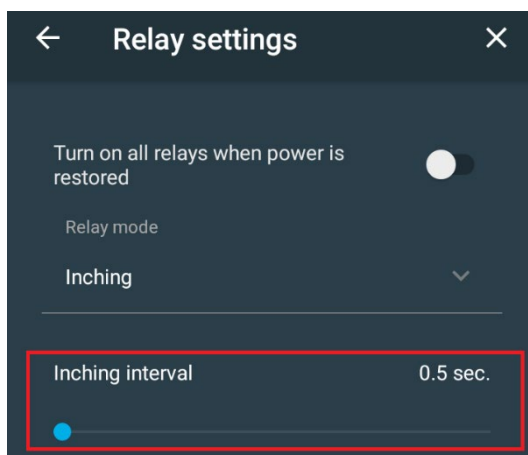

“Turn on all relays when power is restored” - activating this option allows you to keep the relay in its last state when the power is turned off and then turned on. By default, this option is inactive, therefore, when the power supply is turned off and then turned on, the relays will remain disabled.

3.3.5. Relay schedule

Relay schedule.

For each relay channel, you can **create an on / off schedule** for each day of the week.

To do this, **go to the required channel** and create a schedule.

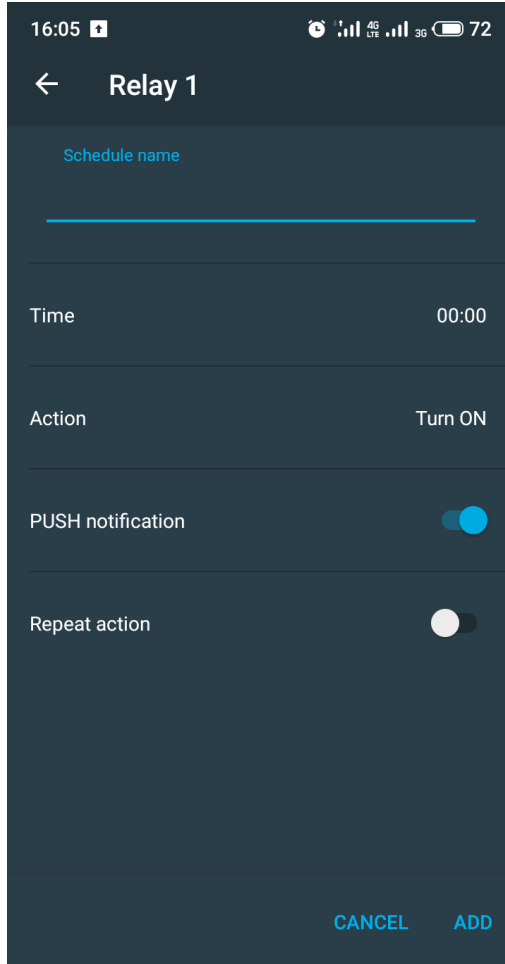

16:05 [location icon] [signal strength] 4G LTE [signal strength] 3G [battery icon] 72

← Relay 1

Schedule name

Time 00:00

Action Turn ON

PUSH notification

Repeat action

CANCEL ADD

Schedule name - name of the schedule.

Time - activation time.

PUSH notification - enable PUSH notifications.

Repeat action - select the days of the week on which this schedule will be activated.

3.3.6. Shared access

To share the device with another user you need to enter the email of the user, with whom you want to share the device, registered in Partizan Cloud

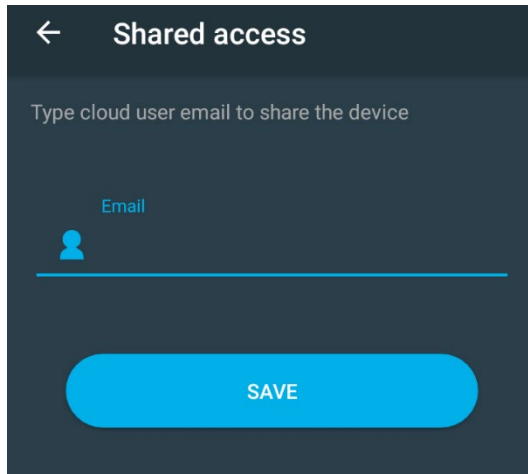

3.3.7. Delete the device

Delete the device from your account.

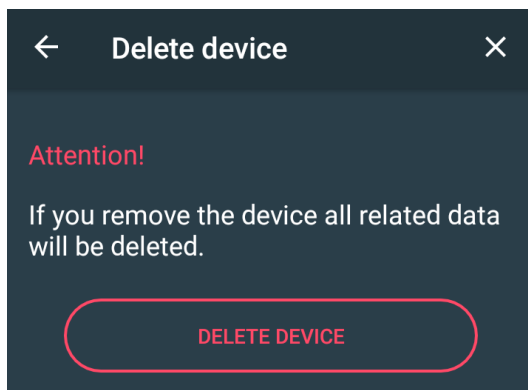

To delete the device press **“DELETE DEVICE”**.

Technical support:

E-mail: support@partizan.global

Skype: partizan-support

Chat: +420 777 054 888 (Viber, Telegram, WhatsApp)



Technical support working time:

<https://partizan.global/support/technical-support>



Partizan software:

<https://apps.partizan.global/>